

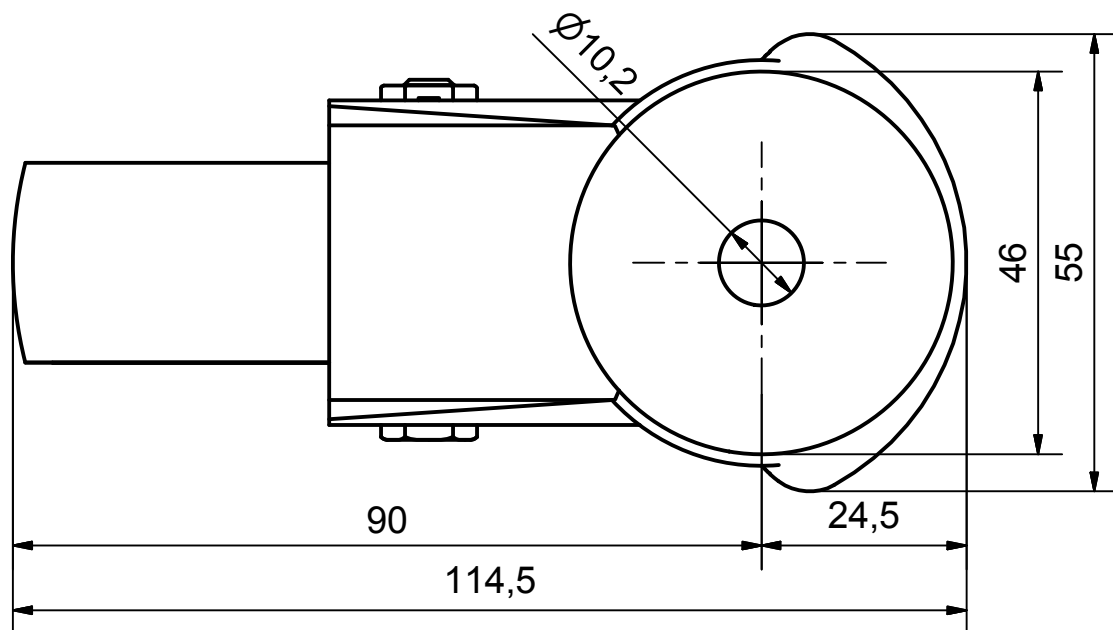

**Load Capacity: 70kg, for speed up to 4km/h
(According to EN 12530)**



 PRODUCTION OF INSTITUTIONAL CASTORS AND WHEELS THESSALONIKI - GREECE	PERMIS. VARIATIONS:		PART No:	
	SURFACE FINISH :		UNF . DIM.:	
This drawing is the property of RODA S.A. It must neither be reproduced in any manner nor shall it be submitted to third parties or competitors without our written consent	DESIGNED	9/7/2013	E.POLIMEROPOULOU	PART NAME : M.100.PA.HS PART DESCRIPTION : Swivel castor, steel support, bolt hole fitting (10,2mm).Wheel 100x24mm,black polypropylene plain bearing
	DRAWN	9/7/2013	E.POLIMEROPOULOU	
	CHECKED	9/7/2013	H.SAATZOGLOU	
C3				DRAWING NUMBER :
B2				
A1				DRAWING NUMBER :
A/A				
QUANTITY			SCALE	
REPLACE :				